

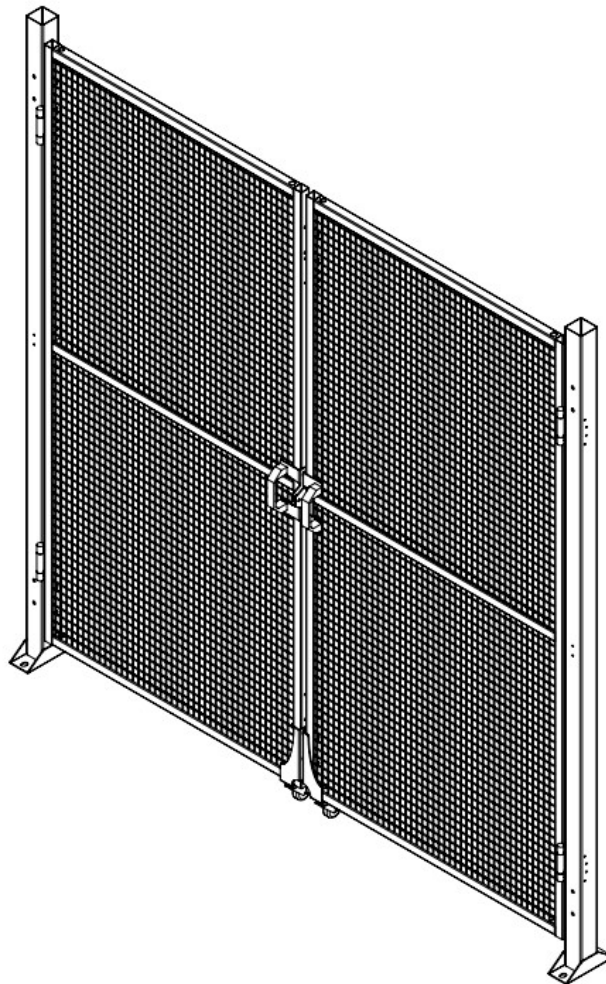









Installation Instruction Of Swing Fence Barrier





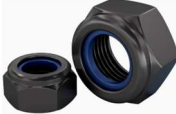

List of installation accessories			
Code	Spare parts Name	picture	QTY
A	Gate post		2
B	Mesh panel		2
C	handle kit		1
D	Magnet handle kit-01		1
E	Auto close hinge for door		4
F	Wheel kit		1
G	M5*15 Black flat round head bolt		32
H	M8*45 Black flat round head bolt		4

Safety-Machine Guarding fence

I	M8 Black nut		4
J	M8*16*1.5 Flat washer		16

Assembly steps

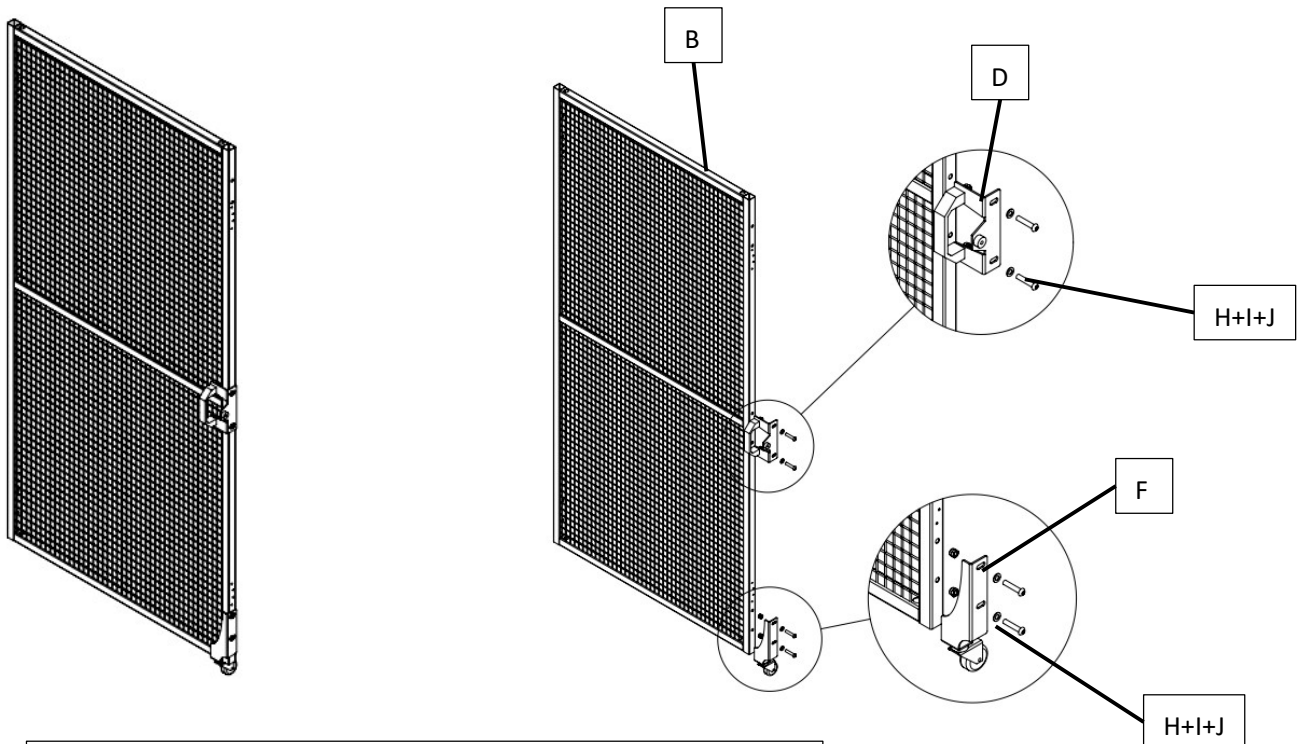

Step 1

B	
D	
F	
H	
I+J	



The installation of the left and right doors follows the same principle: install the left pulley on the left door and the right pulley on the right door.

Step 2

A	
E	
G	

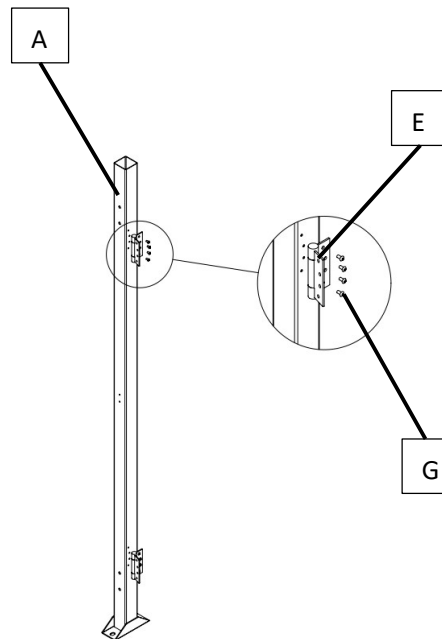
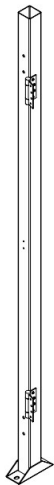

Step 3

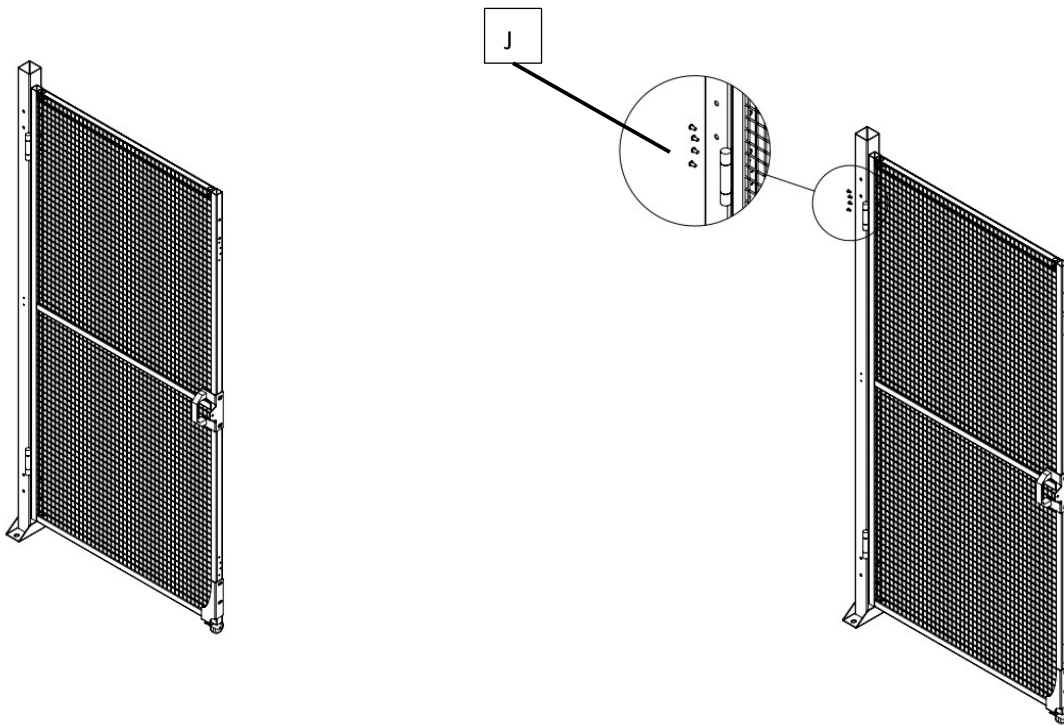

Step 4

